



Karta výrobku -  
**Strešný sendvičový  
panel**

**SPR CORE** WOOL

THE POWER OF ROOFS



# Karta výrobku

## Strešný sendvičový panel

**SPR CORE<sup>WOOL</sup>**



Naskenujte kód a zistíte o výrobku viac!

Sendvičové panely predstavujú inovatívny produkt, ktorý spĺňa požiadavky moderného stavebníctva.

Umožňujú vyhotovenie opláštenia striech priemyselných a verejných budov.

Pre investora predstavujú vysokú kvalitu za dobrú cenu, pre architekta veľa možností realizácie projektu, pre stavbyvedúceho rýchlu a jednoduchú montáž, pre stavebný dozor prístupné a transparentné možnosti verifikácie priebehu celého procesu realizácie výstavby od momentu dodania až po prevzatie objektu pre účely jeho používania.



# Technické údaje

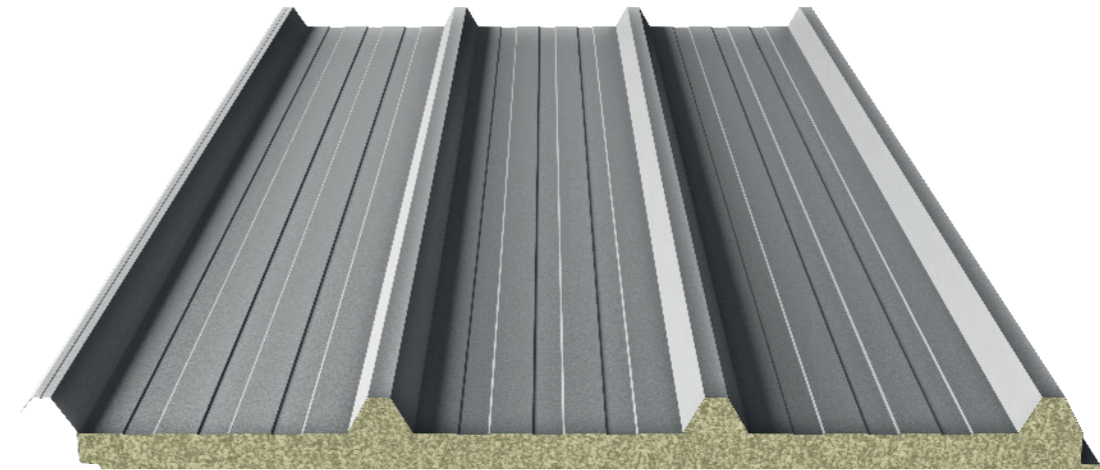

## Prierez panelu

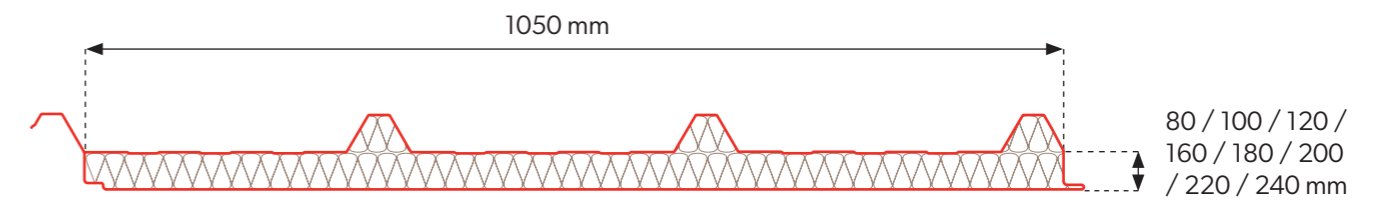

## Spájanie panelov

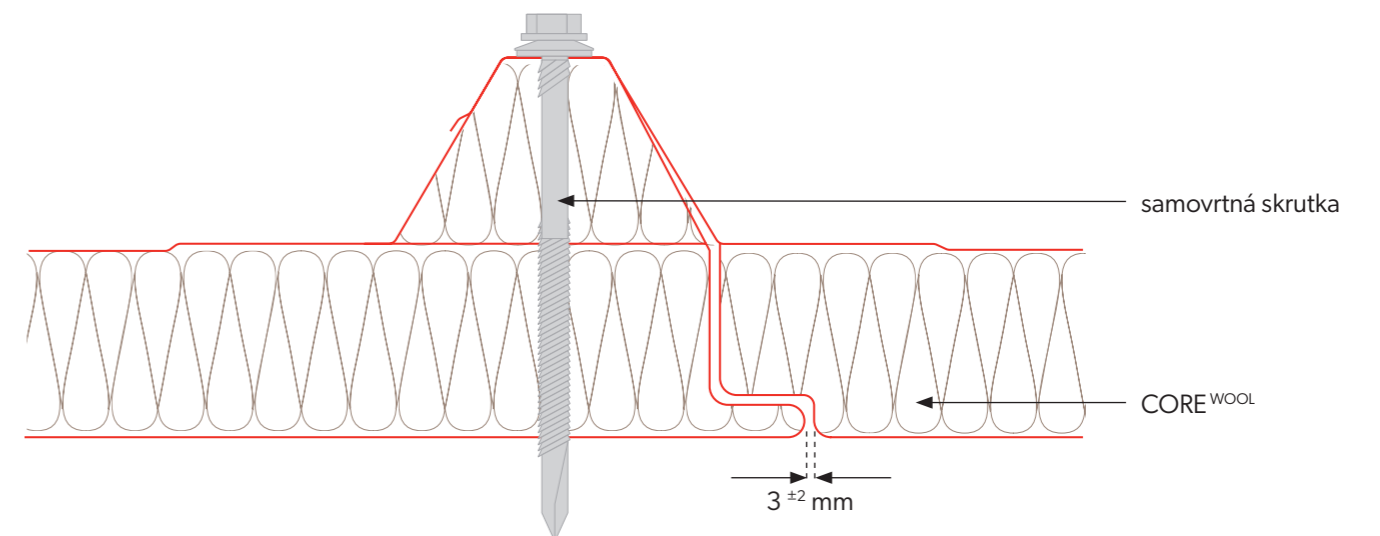

V prípade sendvičových panelov s jadrom z minerálnej vlny sa odporúča použiť tesniacu hmotu v zámkoch panelu aplikovanú priamo na mieste.

## Technické parametre

Jadro	VLNA							
Hustota [kg/m <sup>3</sup> ]	100 ± 10							
Hrúbka WOOL dosky [mm]	80	100	120	160	180	200	220	240
Hmotnosť [kg/m <sup>2</sup> ]	17,8	19,8	21,8	25,8	27,8	29,8	31,8	33,8
Úžitková šírka [mm]	1050							
Celková šírka [mm]	1127							
Min. dĺžka dosky [mb]	2,0							
Max. dĺžka dosky [mb]	15,0							
Hrúbka plechu vonkajšia / vnútorná [mm]	0,5-0,7 / 0,5-0,7							
Faktor U [W/m <sup>2</sup> K]	0,54	0,43	0,36	0,27	0,24	0,22	0,20	0,18
Stupeň šírenia požiaru	NRO							
Typ profilovania vonkajšie / vnútorné	[T40] / [M], [T], [F]							
Odolnosť proti korózii vonkajšia / vnútorná	C1, C2, C3 (C4 ÷ C5) / A1 (A2 ÷ A5)							
Štandardné nátery	Poliester Interior [INT], Poliester Standard [RAL], HERCULIT [HC], MULTILAYER 40 [MLT]							
Špeciálne nátery	PVDF, PUR, PVC (P), PVC (F) - FoodSafe							
Prislušenstvo	upevňovací systém, tesnenia, lemovanie, strešný svetlík SPR-SKY							

## Balenie panelov

Hrúbka dosky [mm]	Modulová šírka [mm]	Počet dosiek v balíku [ks]	Počet balíkov na aute [ks]	Maximálna výška balíka [mm]	Výška balíkov [mm]	Hmotnosť dosky [kg/m <sup>2</sup> ]	Hmotnosť 1 balíka [kg]	Povrch dosiek [m <sup>2</sup> /auto]**
80	1050	12	4	1300	2600	17,8	3027,8	680,4
100	1050	10	4	1300	2600	19,8	2806,7	567,0
120	1050	8	4	1220	2440	21,8	2472,1	453,6
160	1050	6	4	1180	2360	25,8	2194,3	340,2
180	1050	6	4	1300	2600	27,8	2364,4	340,2
200	1050	4	4	980	1960	29,8	1689,7	226,8
220	1050	4	4	1060	2120	31,8	1803,1	226,8
240	1050	4	4	1140	2280	33,8	1916,5	226,8

! \*\* Plocha panelov na aute počítaná pre panely s dĺžkou 13,5 m.

## Vonkajšie profilovanie

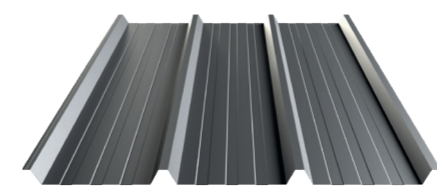

TRAPEZOIDAL 40 [T40]



## Vnútorné profilovanie

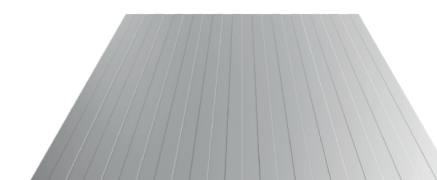

TRAPEZOIDAL [T]

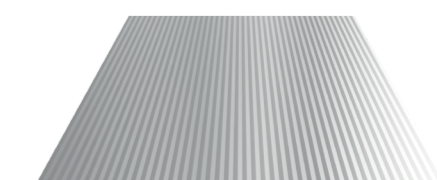
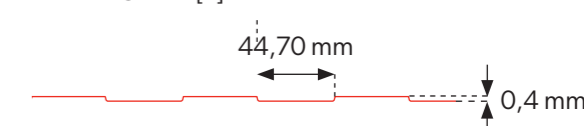

MICRO RIB [M]

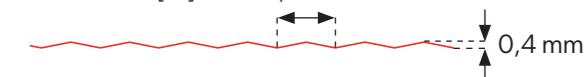

FLAT [F]



Vnútorné a vonkajšie profilovanie je dostupné v ľubovoľnej konfigurácii.



POZOR! Vzhľadom na štruktúru sendvičových panelov s profilmi FLAT [F] môže dochádzať k efektu tzv. „vlnenia“ plechu. Pre tento typ produktov je to prirodzený jav. Pre výber optimálneho riešenia odporúčame kontaktovať technické oddelenie.

## Povrchové úpravy a farebné prevedenia

**POLIESTER Interior [INT]** - dostupné farby pre vnútorné opláštenia

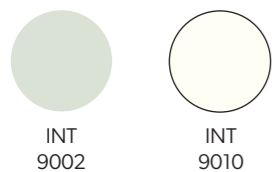

**POLIESTER Standard [RAL]** - dostupné farby pre vonkajšie opláštenia



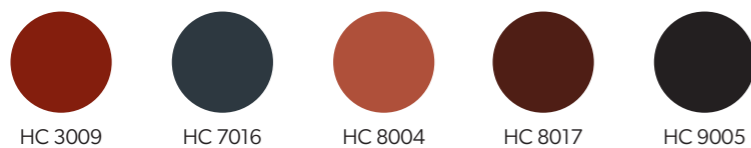

**HERCULIT [HC]**



**MULTILAYER 40 [MLT]** - dostupné farby pre vonkajšie opláštenia



 Technológia tlače neumožňuje presné prevedenie farieb, preto majú uvedené farby orientačný charakter a od skutočných odtieňov sa môžu nepatrne líšiť.

 Na individuálnu objednávku sú dostupné aj neštandardné farby a povrchové úpravy, okrem predstavenej palety (PVDF, PUR, PVC (P), PVC (F) - FoodSafe).

## Parametre povrchových úprav

Kód	Hrúbka povrchovej úpravy	Odolnosť voči korózii	Odolnosť voči UV žiareniu
POLIESTER Interior [INT]	15 µm	RA2	nevzťahuje sa
POLIESTER Standard [RAL]	25 µm	RC3	RUV2
HERCULIT [HC]	35 µm	RC4	RUV4
MULTILAYER 40 [MLT]	40 µm	RC3	RUV3

## Poznámky





Modular roofing tiles  
**MODULAR SERIES**



Compact roofing tiles  
**COMPACT SERIES**



Steel roofing tiles  
**CLASSIC SERIES**



Retro roof tiles  
**RETRO SERIES**



Roof panels  
**PANEL SERIES**



INTEGRATED  
**PV PANELS**



Steel roof gutter system  
**INGURI**



**TRAPEZOIDAL**  
SHEETS



**FLAT METAL**  
SHEETS



**FLASHINGS**



**ACCESORIES**



**Roof Sandwich**  
PANELS



**Wall Sandwich**  
PANELS



Facade cladding  
**SKRIN, LINEA, SINUS**



Wall cassette &  
**PROSYSTEM**



Uncoiling and slitting  
**SERVICES**



Flat sheets and cutting  
**SERVICES**



**PERFORATION**  
of sheets

