



Karta výrobku -
**Strešný sendvičový
panel**

SPR CORE WOOL

THE POWER OF ROOFS



Karta výrobku

Strešný sendvičový panel

SPR CORE^{WOOL}



Naskenujte kód a zistíte o výrobku viac!

Sendvičové panely predstavujú inovatívny produkt, ktorý spĺňa požiadavky moderného stavebníctva.

Umožňujú vyhotovenie opláštenia striech priemyselných a verejných budov.

Pre investora predstavujú vysokú kvalitu za dobrú cenu, pre architekta veľa možností realizácie projektu, pre stavbyvedúceho rýchlu a jednoduchú montáž, pre stavebný dozor prístupné a transparentné možnosti verifikácie priebehu celého procesu realizácie výstavby od momentu dodania až po prevzatie objektu pre účely jeho používania.



Technické údaje

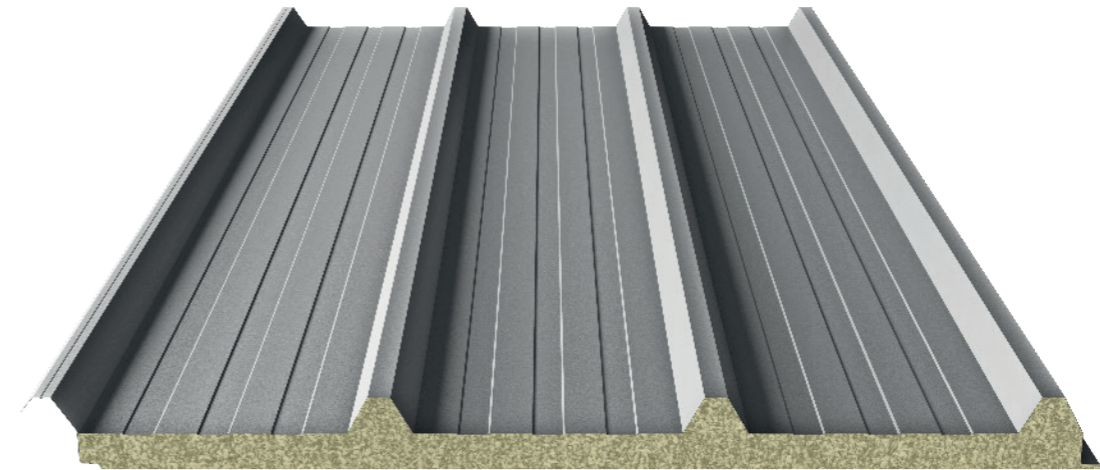

Prierez panelu

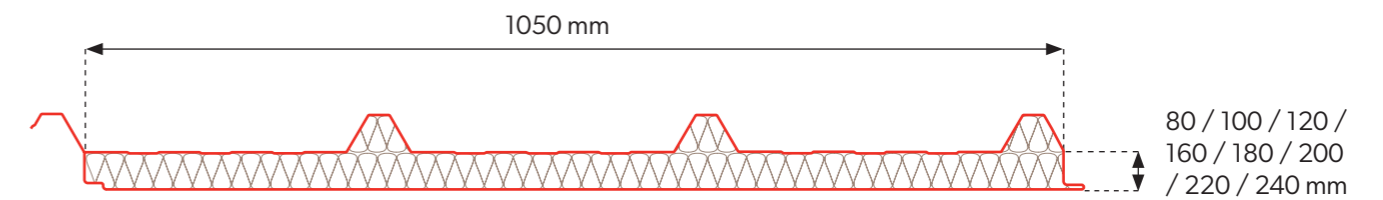

Spájanie panelov

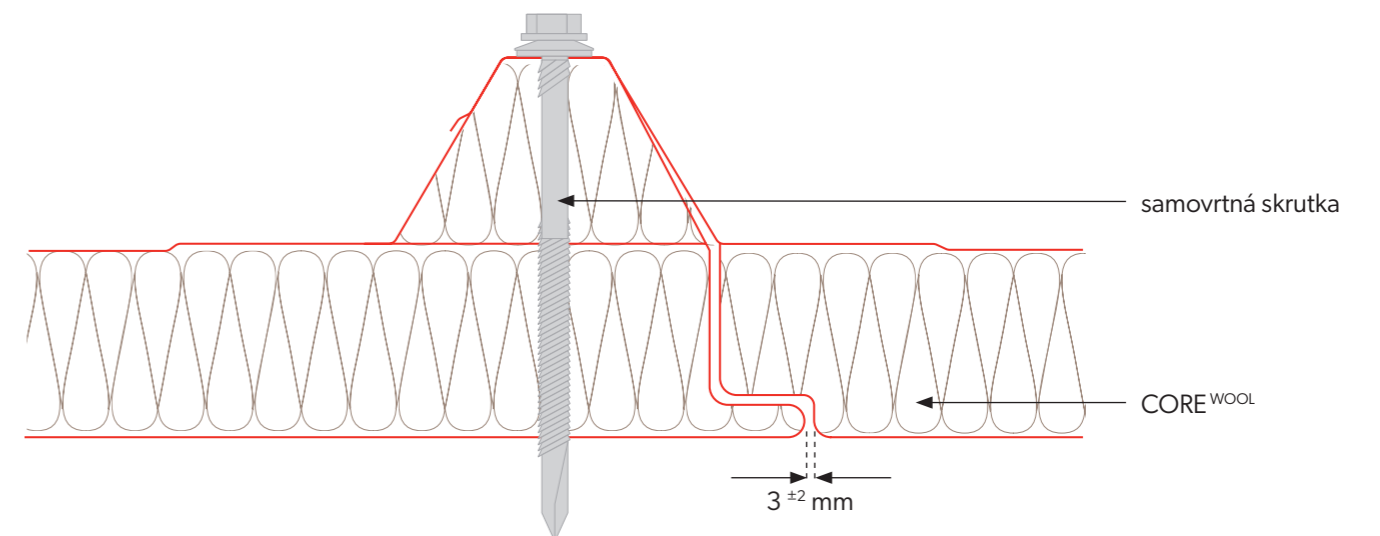

V prípade sendvičových panelov s jadrom z minerálnej vlny sa odporúča použiť tesniacu hmotu v zámkoch panelu aplikovanú priamo na mieste.

Technické parametre

| | | | | | | | | |
|---------------------------------------------|----------------------------------------------------------------------------------------|------|------|------|------|------|------|------|
| Jadro | VLNA | | | | | | | |
| Hustota [kg/m ³] | 100 ± 10 | | | | | | | |
| Hrúbka WOOL dosky [mm] | 80 | 100 | 120 | 160 | 180 | 200 | 220 | 240 |
| Hmotnosť [kg/m ²] | 17,8 | 19,8 | 21,8 | 25,8 | 27,8 | 29,8 | 31,8 | 33,8 |
| Úžitková šírka [mm] | 1050 | | | | | | | |
| Celková šírka [mm] | 1127 | | | | | | | |
| Min. dĺžka dosky [mb] | 2,0 | | | | | | | |
| Max. dĺžka dosky [mb] | 15,0 | | | | | | | |
| Hrúbka plechu vonkajšia / vnútorná [mm] | 0,5-0,7 / 0,5-0,7 | | | | | | | |
| Faktor U [W/m ² K] | 0,54 | 0,43 | 0,36 | 0,27 | 0,24 | 0,22 | 0,20 | 0,18 |
| Stupeň šírenia požiaru | NRO | | | | | | | |
| Typ profilovania vonkajšie / vnútorné | [T40] / [M], [T], [F] | | | | | | | |
| Odolnosť proti korózii vonkajšia / vnútorná | C1, C2, C3 (C4 ÷ C5) / A1 (A2 ÷ A5) | | | | | | | |
| Štandardné nátery | Poliester Interior [INT], Poliester Standard [RAL], HERCULIT [HC], MULTILAYER 40 [MLT] | | | | | | | |
| Špeciálne nátery | PVDF, PUR, PVC (P), PVC (F) - FoodSafe | | | | | | | |
| Prislušenstvo | upevňovací systém, tesnenia, lemovanie, strešný svetlík SPR-SKY | | | | | | | |

Balenie panelov

| Hrúbka dosky [mm] | Modulová šírka [mm] | Počet dosiek v balíku [ks] | Počet balíkov na aute [ks] | Maximálna výška balíka [mm] | Výška balíkov [mm] | Hmotnosť dosky [kg/m ²] | Hmotnosť 1 balíka [kg] | Povrch dosiek [m ² /auto]** |
|-------------------|---------------------|----------------------------|----------------------------|-----------------------------|--------------------|-------------------------------------|------------------------|----------------------------------------|
| 80 | 1050 | 12 | 4 | 1300 | 2600 | 17,8 | 3027,8 | 680,4 |
| 100 | 1050 | 10 | 4 | 1300 | 2600 | 19,8 | 2806,7 | 567,0 |
| 120 | 1050 | 8 | 4 | 1220 | 2440 | 21,8 | 2472,1 | 453,6 |
| 160 | 1050 | 6 | 4 | 1180 | 2360 | 25,8 | 2194,3 | 340,2 |
| 180 | 1050 | 6 | 4 | 1300 | 2600 | 27,8 | 2364,4 | 340,2 |
| 200 | 1050 | 4 | 4 | 980 | 1960 | 29,8 | 1689,7 | 226,8 |
| 220 | 1050 | 4 | 4 | 1060 | 2120 | 31,8 | 1803,1 | 226,8 |
| 240 | 1050 | 4 | 4 | 1140 | 2280 | 33,8 | 1916,5 | 226,8 |

! ** Plocha panelov na aute počítaná pre panely s dĺžkou 13,5 m.

Vonkajšie profilovanie

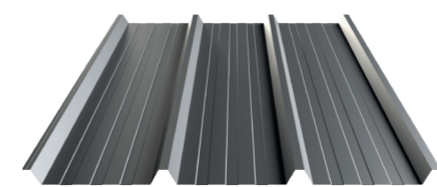

TRAPEZOIDAL 40 [T40]

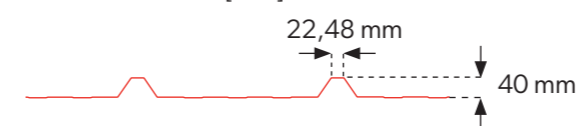

Vnútorné profilovanie

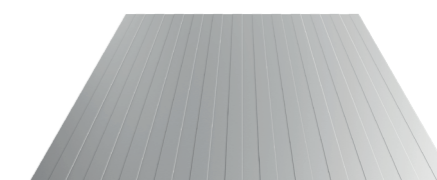

TRAPEZOIDAL [T]

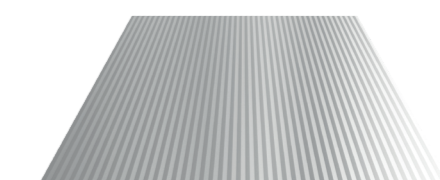
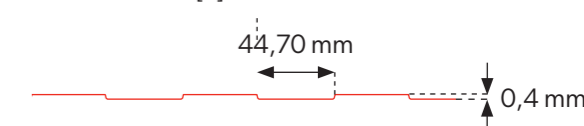

MICRO RIB [M]

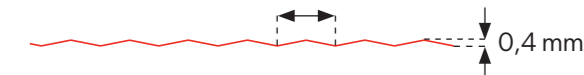

FLAT [F]



Vnútorné a vonkajšie profilovanie je dostupné v ľubovoľnej konfigurácii.

Povrchové úpravy a farebné prevedenia

POLIESTER Interior [INT] - dostupné farby pre vnútorné opláštenia

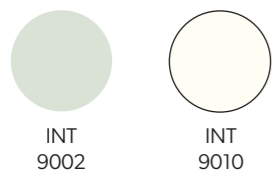

POLIESTER Standard [RAL] - dostupné farby pre vonkajšie opláštenia



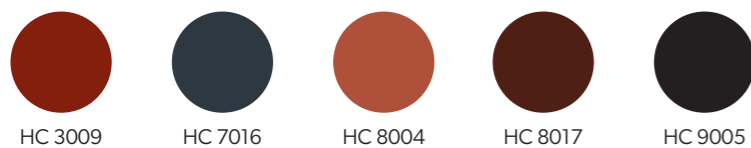

HERCULIT [HC]



MULTILAYER 40 [MLT] - dostupné farby pre vonkajšie opláštenia



 Technológia tlače neumožňuje presné prevedenie farieb, preto majú uvedené farby orientačný charakter a od skutočných odtiev sa môžu nepatrne líšiť.

 Na individuálnu objednávku sú dostupné aj neštandardné farby a povrchové úpravy, okrem predstavenej palety (PVDF, PUR, PVC (P), PVC (F) - FoodSafe).

Parametre povrchových úprav

| Kód | Hrúbka povrchovej úpravy | Odolnosť voči korózii | Odolnosť voči UV žiareniu |
|--------------------------|--------------------------|-----------------------|---------------------------|
| POLIESTER Interior [INT] | 15 μm | RA2 | nevzťahuje sa |
| POLIESTER Standard [RAL] | 25 μm | RC3 | RUV2 |
| HERCULIT [HC] | 35 μm | RC4 | RUV4 |
| MULTILAYER 40 [MLT] | 40 μm | RC3 | RUV3 |

Poznámky





Modular roofing tiles
MODULAR SERIES



Compact roofing tiles
COMPACT SERIES



Steel roofing tiles
CLASSIC SERIES



Retro roof tiles
RETRO SERIES



Roof panels
PANEL SERIES



INTEGRATED
PV PANELS



Steel roof gutter system
INGURI



TRAPEZOIDAL
SHEETS



FLAT METAL
SHEETS



FLASHINGS



ACCESORIES



Roof Sandwich
PANELS



Wall Sandwich
PANELS



Facade cladding
SKRIN, LINEA, SINUS



Wall cassette &
PROSYSTEM



Uncoiling and slitting
SERVICES



Flat sheets and cutting
SERVICES



PERFORATION
of sheets

