



Product card - **Wall sandwich panel with concealed fastening**

SPW-H CORE^{PIR}

THE POWER OF ROOFS



Product card

Wall sandwich panel with concealed fastening

SPW-H CORE^{PIR}



Scan the code
and learn more
about the product!

Sandwich panels are high-performance products that meet the requirements of the modern construction market.

Suitable for the construction of exterior and interior wall claddings and ceilings of industrial or public utility facilities.

For the investor, it is a high quality product at a good price. For architects, it offers many possibilities in relation to the design intent. For construction managers, quick and easy installation. For construction supervision, friendly and transparent possibilities to verify the course of the entire process of construction execution from delivery until build acceptance.

Technical information

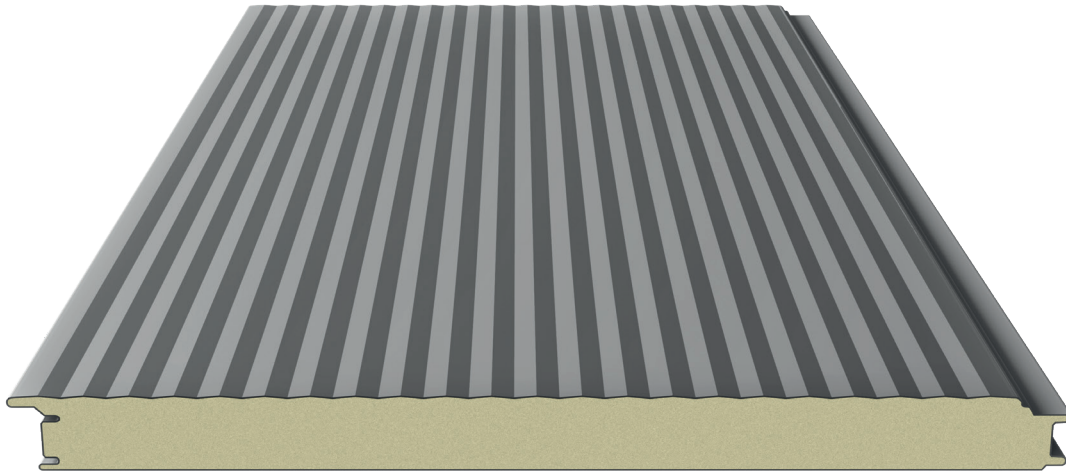

Board cross-section

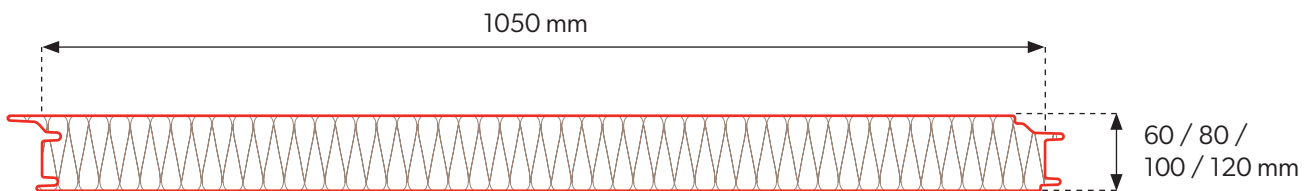

Joining of panels

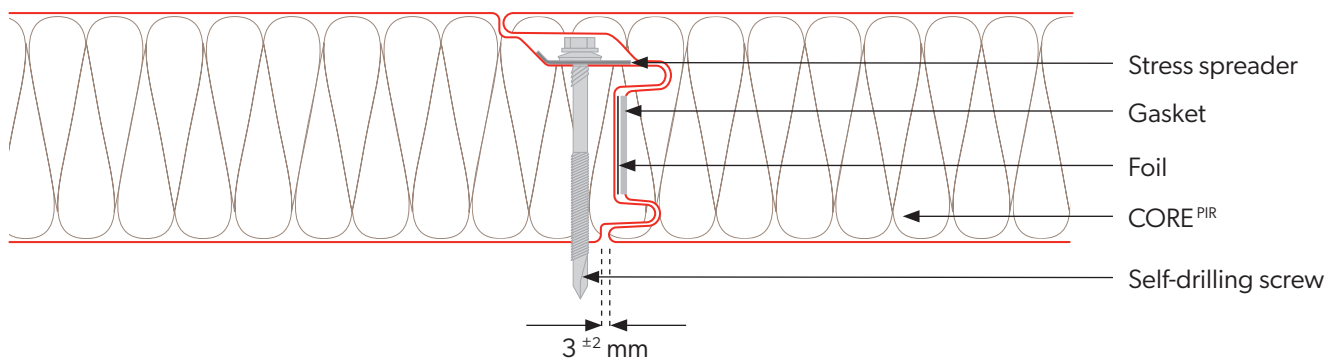

Technical information

Core	PIR			
Density [kg/m ³]	40 ± 3			
PIR panel thickness [mm]	60	80	100	120
Weight [kg/m ²]	9,5	10,3	11,1	11,9
Effective width [mm]	1050			
Total width [mm]	1102			
Min. panel length [m]	2,0			
Max. panel length [m]	15,0			
Outer/inner sheet thickness [mm]	0,4-0,7 / 0,4-0,7			
U-value [W/m ² K]	0,37	0,28	0,22	0,18
Fire spread degree	NRO			
Type of external / internal profiling	[M], [T], [R], [F] / [M], [T], [F]			
External / internal corrosion resistance	C1, C2, C3 (C4 ÷ C5) / A1 (A2 ÷ A5)			
Standard coatings	Poliester Interior [INT], Poliester Standard [RAL], HERCULIT [HC], MULTILAYER 40 [MLT]			
Special coatings	PVDF, PUR, PVC (P), PVC (F) - FoodSafe			
Accessories	fixing system, seals, flashings, rooflight SPR-SKY			

Packaging of sandwich panels

Panel thickness [mm]	Modular width [mm]	Number of panels per pack [pcs]	Number of packages on a vehicle [pcs]	Maximum package height [mm]	Package height [mm]	Panel weight [kg/m ²]	Weight of 1 package [kg]	Surface area of panels [m ² /car]**
60	1050	13	6	880	2640	9,5	1750,6	1105,7
80	1050	15	4	1300	2600	10,3	2190,0	850,5
100	1050	12	4	1300	2600	11,1	1888,1	680,4
120	1050	10	4	1300	2600	11,9	1686,8	567,0



** Surface area of panels on car calculated for panel lengths of 13.5 m.

External profiling

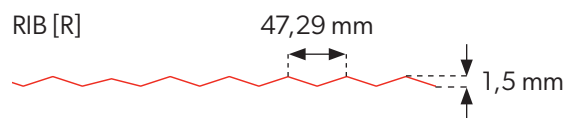
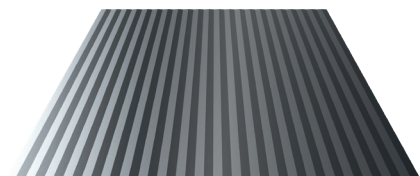
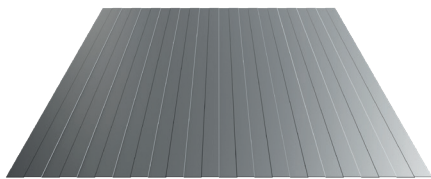
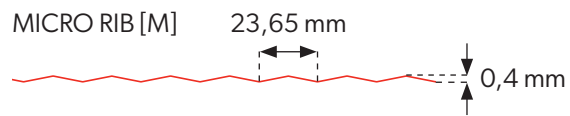
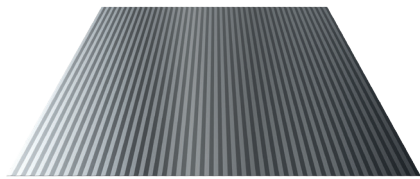

FLAT [F]

Internal profiling

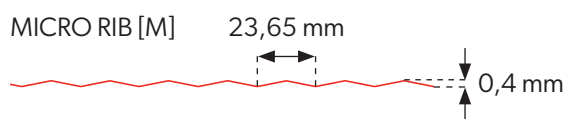
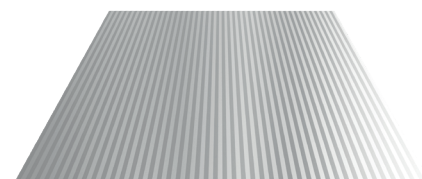
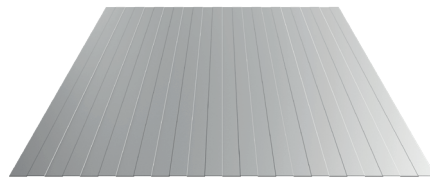

FLAT [F]



Internal and external profiling are available in any configuration.



ATTENTION! Due to the structure of sandwich panels with FLAT [F] profiles, the so-called effect may occur. „waves“ of the sheet metal. This is a natural phenomenon for this type of products. We recommend contacting the technical department to choose the optimal solution.

Coatings and colors

POLIESTER Interior [INT] - Available colors for interior cladding

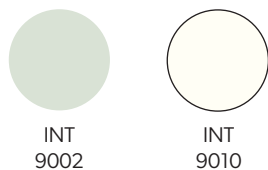

POLIESTER Standard [RAL] - Available colors for exterior cladding

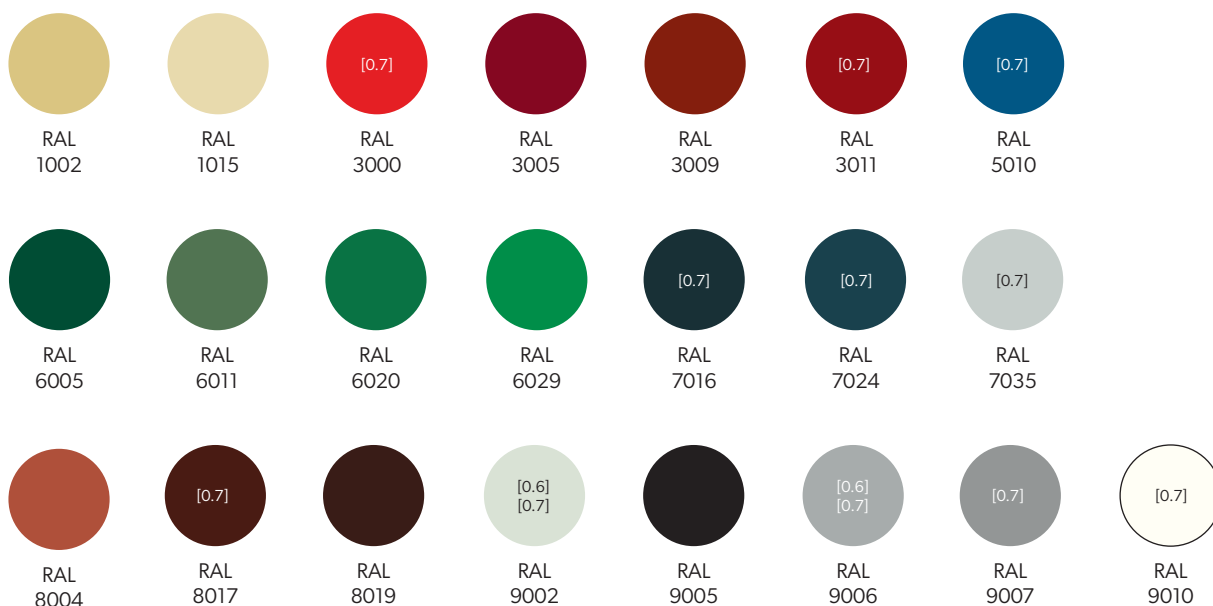

HERCULIT [HC]

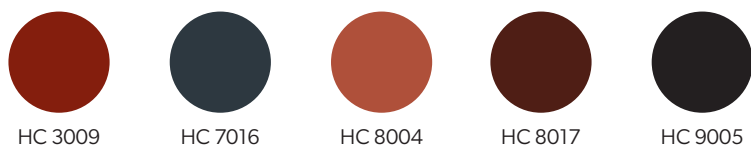

MULTILAYER 40 [MLT] - Available colors for exterior cladding



Printing technology does not allow faithful rendering of colors. Therefore the colors shown are indicative and may differ from actual colors.



In addition, on individual order, non-standard colors and coatings are available, outside the palette shown (PVDF, PUR, PVC (P), PVC (F) - FoodSafe).



Modular roofing tiles
MODULAR SERIES



Compact roofing tiles
COMPACT SERIES



Steel roofing tiles
CLASSIC SERIES



Retro roof tiles
RETRO SERIES



Roof panels
PANEL SERIES



INTEGRATED
PV PANELS



Steel roof gutter system
INGURI



TRAPEZOIDAL
SHEETS



FLAT METAL
SHEETS



FLASHINGS



ACCESORIES



Roof Sandwich
PANELS



Wall Sandwich
PANELS



Facade cladding
SKRIN, LINEA, SINUS



Wall cassette &
PROSYSTEM



Uncoiling and slitting
SERVICES



Flat sheets and cutting
SERVICES



PERFORATION
of sheets

